

WEISER

SMARTCODE 10

ELECTRONIC LEVER

Installation and User Guide

ENGLISH

Required tools



Additional Tools (depending on application)



Weiser
1-800-501-9471
www.weiserlock.com

Parts in the box

| | | | |
|----------------|--|--|---------------------|
| <p>Latch</p> | <p>Exterior Assembly</p> <p>Traditional Contemporary</p> | <p>Interior Assembly</p> <p>Traditional Contemporary</p> | <p>9V Battery</p> |
| <p>Strike</p> | <p>SmartKey™ Tool</p> | <p>Keys</p> | <p>Allen Wrench</p> |
| <p>Spindle</p> | <p>Levers</p> <p>Traditional Contemporary</p> | <p>Fasteners</p> <p>26298</p> <p>68221</p> | |

1 Prepare the door and check dimensions

If drilling a new door, use the supplied template and the complete door drilling instructions available at www.weiserlock.com/doorprep.

- A** Measure to confirm that the hole in the door is 2-1/8" (54 mm).
- B** Measure to confirm that the backset is either 2-3/8" or 2-3/4" (60 or 70 mm).
- C** Measure to confirm that the hole in the door edge is 1" (25 mm).
- D** Measure to confirm that the door is between 1-3/8" and 1-3/4" (35 mm and 44 mm) thick.

*If you are installing this lever below an existing lock or you plan to install a lock above this lever, make sure that the distance between holes is at least 6-1/2" (165 mm).

2 Install the latch and strike

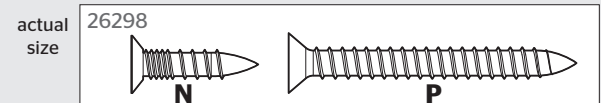

- A** Hold the latch in front of the door hole, with the latch face flush against the door edge.
- B** Are the latch holes centered in the door hole?
 - YES** No adjustment is required. Proceed to next step.
 - NO** Move the pin to extend the latch.
- C** Is the door edge chiseled?
 - YES** Install latch in door with supplied screws.
 - NO** Use a flathead screwdriver to lift tabs on collar of rectangular face to remove it from latch. Install drive-in collar.
- D** Install strike on the door frame.

3 Install the exterior keypad, spindle, and interior assembly



A Install exterior keypad.

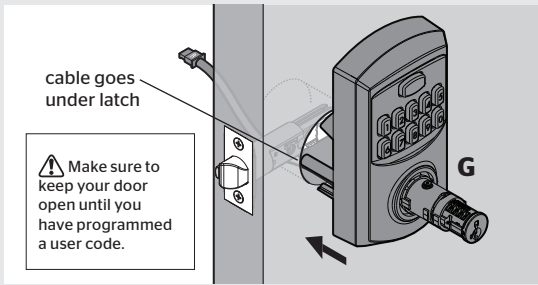

B Install spindle.

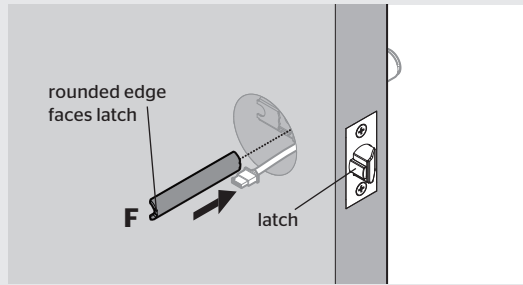

C **OPTIONAL:** Install security set screw.



D Connect and secure cable to interior assembly.

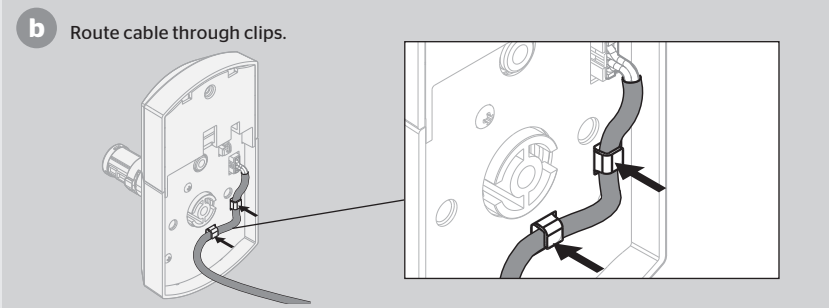
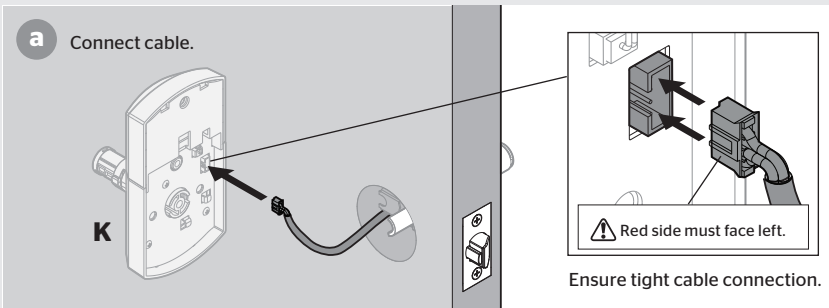

E Install interior assembly and secure with mounting screws.

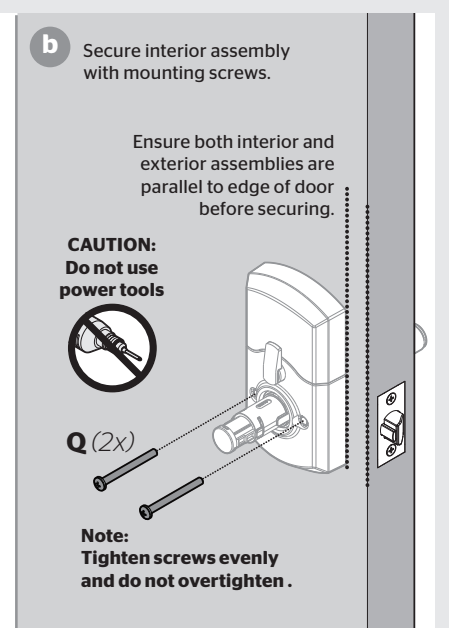
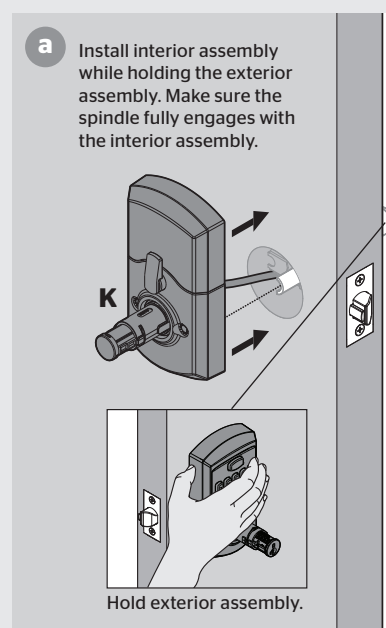

4 Install levers

A Install exterior lever.

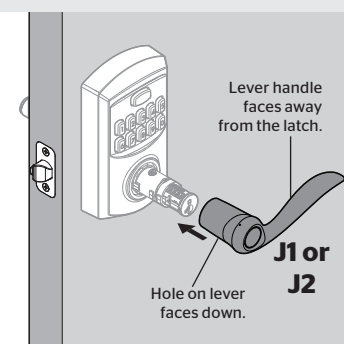

B **!** Insert key and turn 90° clockwise.



C Tighten pre-installed set screw to secure exterior lever.

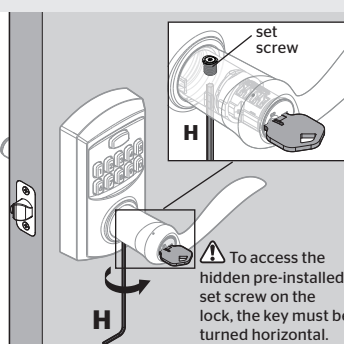

D Turn key back to vertical position to remove it.

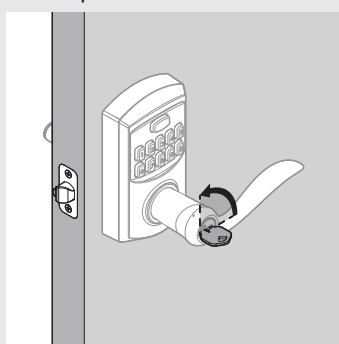

E Install and secure interior lever.

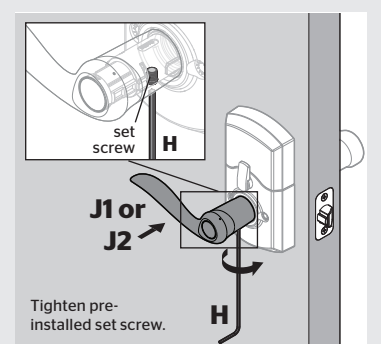

5 Test latch operation

Close door, test latch operation **FROM THE INTERIOR** and make adjustments as needed:

The small bolt of the latch should not enter the strike hole. If it enters the strike hole, reposition strike.

If latch is loose in the strike, adjust the strike tab so it grips the latch bolt better when the door is closed.

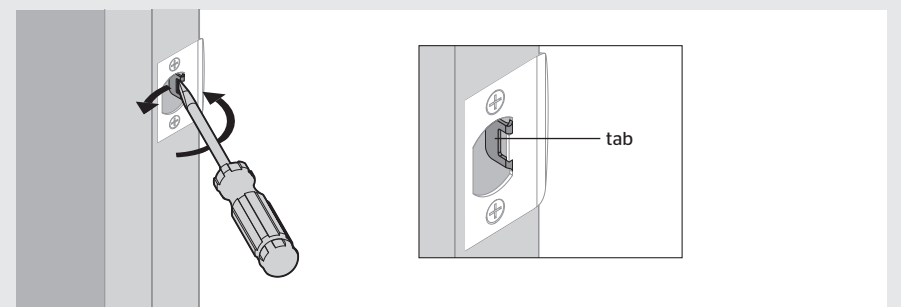
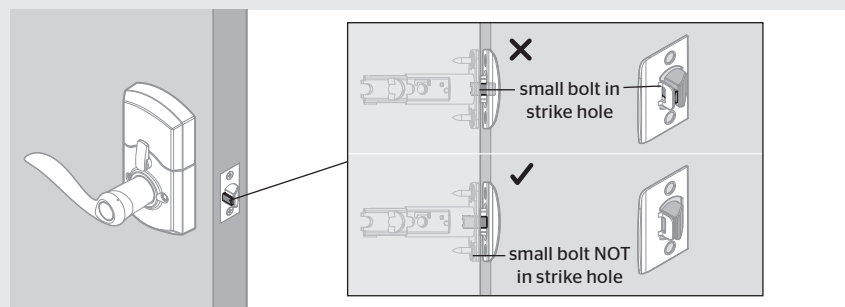

6 Install battery

A Remove interior cover.

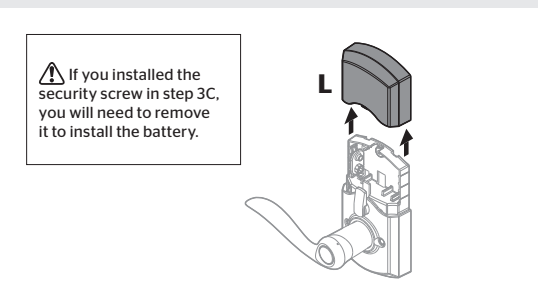

B Connect 9V battery.

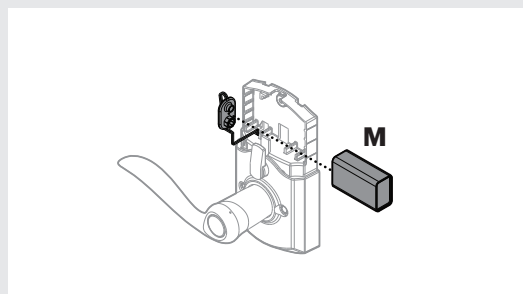

C Secure battery into interior assembly.

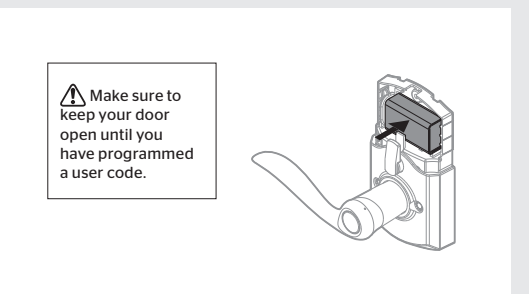

7 Add user codes

Move swiftly during programming. If no digit is pressed for 10 seconds, the system will time out and you will need to restart the procedure.

A Make sure the door is open.

Press and release the Program button. You will hear two beeps.

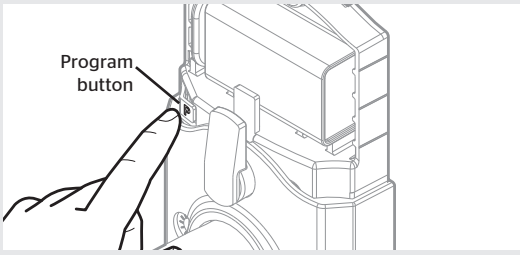

B Press **1**. You will hear one short beep and the keypad will flash green once.

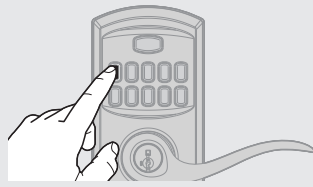

C Press **Weiser**.

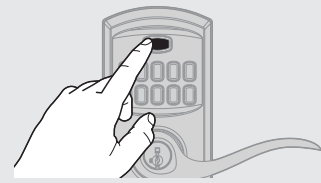

D Enter a User Code. It must be between 4 and 8 digits.

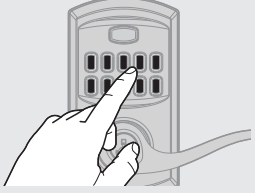

! For security reasons, the first 4 digits of each user code must be unique. For example, you are unable to program a user code **1-2-3-4-5** as well as a user code **1-2-3-4-6**.

E Press **Weiser**.

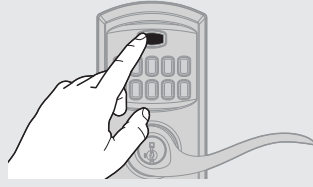

F You will hear one long beep and the keypad will flash green if successful. If you hear three beeps and the keypad flashes red, it was unsuccessful. Repeat from step A.

Reinstall battery cover.

8 OPTIONAL: Enable / Disable Programming Code

A A Programming Code enables you to make changes without needing to access the Program button. This is ideal for landlords to allow programming from the outside, without access to the interior Program button.



Please note that once a Programming Code is enabled, the Program button is disabled and can be used only to factory reset the lock.

B Make sure the door is open. **If you have not enabled a Programming Code**, press and release the Program button. You will hear two beeps.

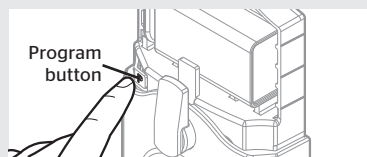

If you have enabled a Programming Code, enter your Programming Code, then press **Weiser**. You will hear one short beep and the keypad will flash green.

C Press **3**. You will hear one short beep and the keypad will flash green.

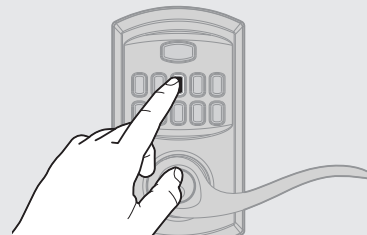

D Press **Weiser**.

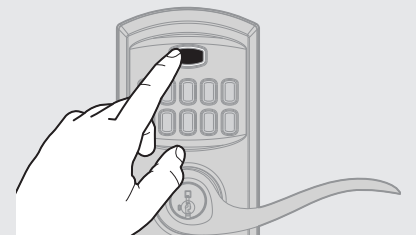

E Enter a Programming Code. It must be between 4 and 8 digits. **The Programming Code cannot be the same as any user code.**

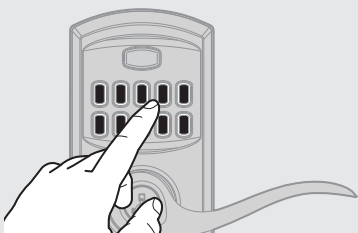

F Press **Weiser**.

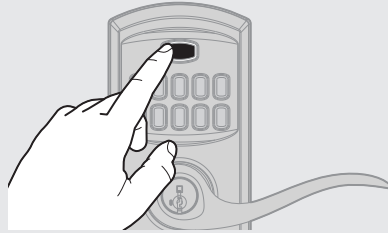

G Re-enter Programming Code.

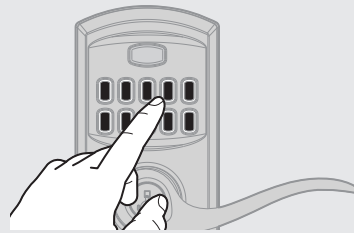

H Press **Weiser**. You will hear one long beep and the keypad will flash green if successful. If you hear three beeps and the keypad flashes red, it was unsuccessful. Repeat from step A.

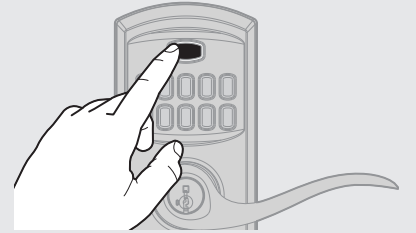

9 Test the lock and review lock functionality

Unlocking the Door with a User Code

With the door open and turn piece set to the auto-lock position, confirm that the code(s) added in previous step can unlock the door.

Enter user code.

The lock will beep twice to indicate that it unlocked.

Tip: You can press the Weiser button before entering your user code to light up the keypad at night.

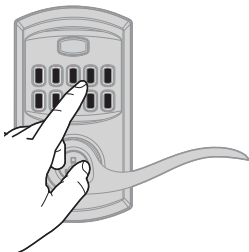

Unlocking the Door with a Key

a To unlock using a key, turn the key clockwise to the horizontal position then turn the lever to open the door.

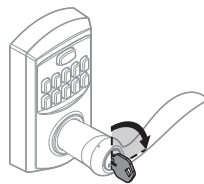

b To remove the key, turn the key back to the vertical position.

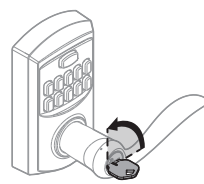

Turnpiece Functions - Choosing a Mode

Auto-lock mode

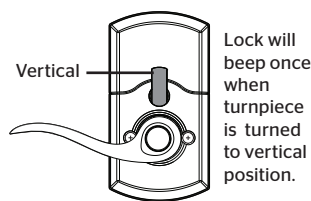

Key or code is needed for entry from the outside.

or

Passage mode

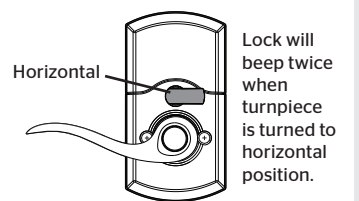

Stays unlocked, allowing entry without a key or code.

Emergency Egress

The interior lever of this lock will always open the door when turned, regardless of whether it is locked or unlocked. This is to allow for a safe and easy exit in case of emergency.

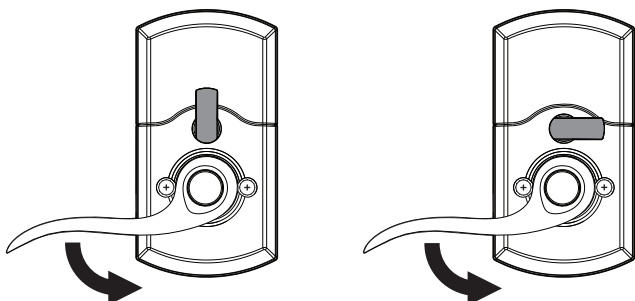

Re-key the lock (if needed)

! **1 IMPORTANT: Remove lever before re-keying.**

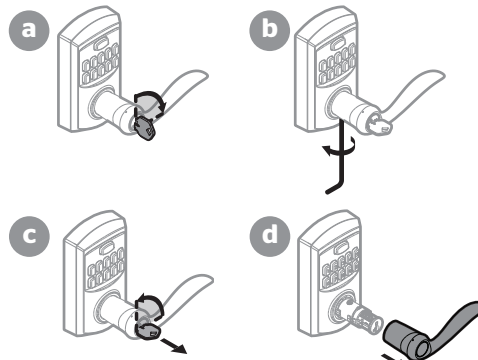

2 Re-key the lock to work with your existing key. See the supplied SmartKey™ Re-key instructions for more information.

GED2700 at a Glance

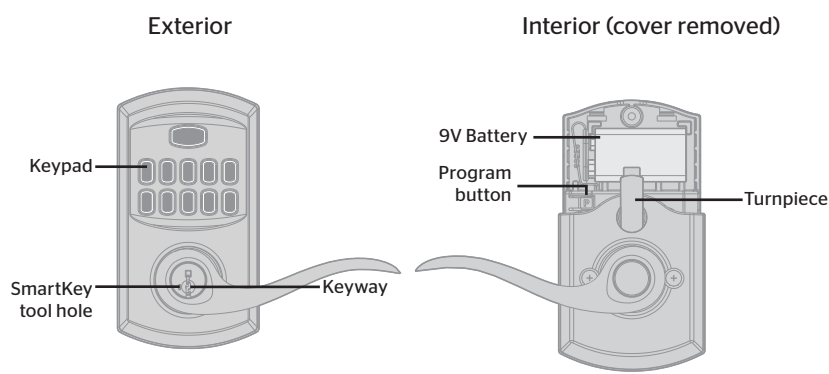

System Signals

| Use Cases | Sound | Light |
|--|----------------|-----------------------|
| Correct user code entered to unlock door | 2 short beeps | 2 short green flashes |
| Lock auto-locks | 1 long beep | 1 long red flash |
| Turnpiece rotated to unlock position | 2 short beeps | None |
| Turnpiece rotated to locked position | 1 long beep | None |
| Low battery alarm | 10 short beeps | 10 short red flashes |
| 3 incorrect user codes entered | 15 long beeps | 15 long red flashes |
| Entering factory reset mode after Program button is pressed and held for 30 seconds. | 1 long beep | None |
| Entering programming mode after pressing and releasing Program button | 2 beeps | None |
| Successful programming | 1 long beep | 1 long green flash |
| Unsuccessful programming | 3 short beeps | 3 short red flashes |

Additional Programming Features

How to add permanent or one-time User Codes

1. Make sure the door is open.
2. **If you have not enabled a Programming Code**, press and release the Program button. You will hear two beeps.

If you have enabled a Programming Code, enter your Programming Code, then press **Weiser**. You will hear one short beep and the keypad will flash green.
3. Press **1** to add a permanent user code that can be used for entry at all times, until deleted.

Press **7** to add a one-time user code. A one-time user code may be used only once, which will be deleted immediately after use (typically used in emergency cases when you need to give one-time access to a person).

You will hear one short beep and the keypad will flash green.
4. Press **Weiser**.
5. Enter a new User Code. It must be between 4 and 8 digits. For security reasons, the first 4 digits of each user code must be unique. For example, you are unable to program a user code 4-8-1-5-1 as well as a user code 4-8-1-5-2.
6. Press **Weiser**. You will hear one long beep and the keypad will flash green if successful. If you hear three beeps and the keypad flashes red, it was unsuccessful. Repeat from step 1.

How to enable/disable User Codes

⚠ If User Codes are disabled (example: when you go on vacation), the lock can only be operated by the key.

1. Make sure the door is open.
2. **If you have not enabled a Programming Code**, press and release the Program button. You will hear two beeps.

If you have enabled a Programming Code, enter your Programming Code, then press **Weiser**. You will hear one short beep and the keypad will flash green.
3. Press **6**. You will hear one short beep and the keypad will flash green.
4. Press **Weiser**. You will hear one long beep and the keypad will flash green if successful. If you hear three beeps and the keypad flashes red, it was unsuccessful. Repeat from step 1.

How to mute/unmute lock

If the lock is muted, you will not hear beeping during programming, normal operation, or system signals. You will still get a low battery alarm.

1. Make sure the door is open.
2. **If you have not enabled a Programming Code**, press and release the Program button. You will hear two beeps.

If you have enabled a Programming Code, enter your Programming Code, then press **Weiser**. You will hear one short beep and the keypad will flash green.
3. Press **5**. You will hear one short beep and the keypad will flash green.
4. Press **Weiser**. You will hear one long beep and the keypad will flash green if successful. If you hear three beeps and the keypad flashes red, it was unsuccessful. Repeat from step 1.

How to delete individual User Codes

1. Make sure the door is open.
2. **If you have not enabled a Programming Code**, press and release the Program button. You will hear two beeps.

If you have enabled a Programming Code, enter your Programming Code, then press **Weiser**. You will hear one short beep and the keypad will flash green.
3. Press **2** to delete a user code.

You will hear one short beep and the keypad will flash green.
4. Press **Weiser**.
5. Enter the User Code you wish to delete. Press **Weiser**.
6. Enter the User Code Again.
7. Press **Weiser**. You will hear one long beep and the keypad will flash green if successful. If you hear three beeps and the keypad flashes red, it was unsuccessful. Repeat from step 1.

How to delete all User Codes

1. Make sure the door is open.
2. **If you have not enabled a Programming Code**, press and release the Program button. You will hear two beeps.

If you have enabled a Programming Code, enter your Programming Code, then press **Weiser**. You will hear one short beep and the keypad will flash green.
3. Press **4**. You will hear one short beep and the keypad will flash green.
4. Press **Weiser**.
5. Enter **9-9-9-9-9-9**.
6. Press **Weiser**.
7. Enter **9-9-9-9-9-9**.
8. Press **Weiser**. You will hear one long beep and the keypad will flash green if successful. If you hear three beeps and the keypad flashes red, it was unsuccessful. Repeat from step 1.

How to change the auto-locking duration

1. Make sure the door is open.
2. **If you have not enabled a Programming Code**, press and release the Program button. You will hear two beeps.

If you have enabled a Programming Code, enter your Programming Code, then press **Weiser**. You will hear one short beep and the keypad will flash green.
3. Press **8**. You will hear one short beep and the keypad will flash green.
4. Press **Weiser**.
5. Enter delay time between 1-99 seconds.
6. Press **Weiser**. You will hear one long beep and the keypad will flash green if successful. If you hear three beeps and the keypad flashes red, it was unsuccessful. Repeat from step 1.

How to enable/disable turnpiece functionality

⚠ A feature for property managers
If the turnpiece is disabled, the lock will always auto-lock after each entry. The turnpiece will rotate but will not activate passage mode. User code or key will always be required for entry.

1. Make sure the door is open.
2. **If you have not enabled a Programming Code**, press and release the Program button. You will hear two beeps.

If you have enabled a Programming Code, enter your Programming Code, then press **Weiser**. You will hear one short beep and the keypad will flash green.
3. Press **9**. You will hear one long beep and the keypad will flash green.
4. Press **Weiser**. You will hear one long beep and the keypad will flash green if successful. If you hear three beeps and the keypad flashes red, it was unsuccessful. Repeat from step 1.

Factory Reset

A factory reset will delete all codes associated with the lock.

1. Make sure the door is open and unlocked.
2. Press and hold the Program button until you hear one long beep (approximately 30 seconds), then release the Program button.
3. Press and release the Program button again. You will hear one short beep.
4. Test with an existing User Code, the lock should not work.

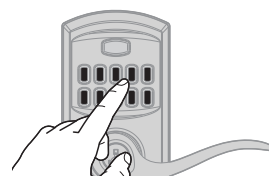
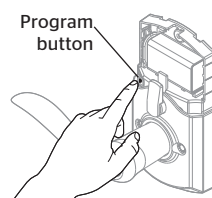

Troubleshooting

Keypad is not responding.

Change battery.

Desired user code cannot be programmed.

For security reasons, the first 4 digits of each user code must be unique. For example, you are unable to program a user code 4-8-1-5-1 as well as a user code 4-8-1-5-2.

Key cannot be removed when unlocked.

This is a feature to ensure the door is always locked and the key is removed (store room function). To remove the key, return the key to vertical position to remove.

Emergency egress function

This lock has an emergency egress function which allows you to exit by turning the lever on the inside, regardless of whether it is in Auto-lock or Passage mode.

Regulatory Compliance

This product complies with standards established by the following regulatory bodies:

- Federal Communications Commission (FCC)
- Industry Canada

FCC

This device complies with Part 15 of the FCC Rules. Operation is subject to the following two conditions:
(1) this device may not cause harmful interference, and
(2) this device must accept any interference received, including interference that may cause undesired operation.

This equipment has been tested and found to comply with the limits for a Class B digital device, pursuant to Part 15 of the FCC Rules. These limits are designed to provide reasonable protection against harmful interference in a residential installation. This equipment generates, uses, and can radiate radio frequency energy and, if not installed and used in accordance with the instructions, may cause harmful interference to radio communications. However, there is no guarantee that interference will not occur in a particular installation. If this equipment does cause harmful interference to radio or television reception, which can be determined

by turning the equipment off and on, the user is encouraged to try to correct the interference by one or more of the following measures:

- Reorient or relocate the receiving antenna.
- Increase the separation between the equipment and receiver.
- Connect the equipment into an outlet on a circuit different from that to which the receiver is connected.
- Consult the dealer or an experienced radio/TV technician for help.

IMPORTANT! Changes or modifications not expressly approved by the manufacturer could void the user's authority to operate the equipment.

Industry Canada

This device complies with Industry Canada licence-exempt RSS standard(s). Operation is subject to the following two conditions: (1) this device may not cause interference, and (2) this device must accept any interference, including interference that may cause undesired operation of the device.

Important Safeguards

1. Read all instructions in their entirety.
2. Familiarize yourself with all warning and caution statements.
3. Remind all users of safety precautions.
4. Protect your user codes and programming code.
5. Dispose of used batteries according to local laws and regulations.

⚠ CAUTION: Prevent unauthorized entry. Since anyone with access to the back panel can change the user codes, you must restrict access to the back panel and routinely check the user codes to ensure they have not been altered without your knowledge. The use of a program code can help protect your system's settings.

⚠ WARNING: This Manufacturer advises that no lock can provide complete security by itself. This lock may be defeated by forcible or technical means, or evaded by entry elsewhere on the property. No lock can substitute for caution, awareness of your environment, and common sense. Builder's hardware is available in multiple performance grades to suit the application. In order to enhance security and reduce risk, you should consult a qualified locksmith or other security professional.